

# Standard Products

---

## Φ2.5 Miniature Jacks



Space-saving and thin-type jacks ranging from signal line 3-pole to 6 pole. >

## Waterproof USB connectors



JIS IPX57 standard -rated and reduced in thickness using our original method. >

## Multi-pole plug and plug cord



Standard products , original plugs for audio and power supply plugs . Fulfil customers' requirements including plug cable machining >

## Φ3.5 Miniature Jacks



Smallest low profile type and cylinder type for cable complying with maximum single line 6-pole. >

## Waterproof Jacks



Complying with JIS standards IPX57 and available for wet-table products . >

## Custom-made products

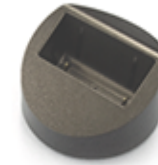

Customization in all product categories, including not only components but also exterior finished products . >

## DC power jacks



JEITA standards, previous standards products and original products. >

## Antennas



Meet your requirements in TV rod antennas for smartphones and antennas for industrial equipment. >

## Parts processing & Jig production



Accept orders including machining of metal and plastic molded parts, production equipment /jigs and contract manufacturing services. >

# Custom Products

---

Customization in all product categories, including not only components but also exterior finished products.



Mount Assy of Jack/Connector

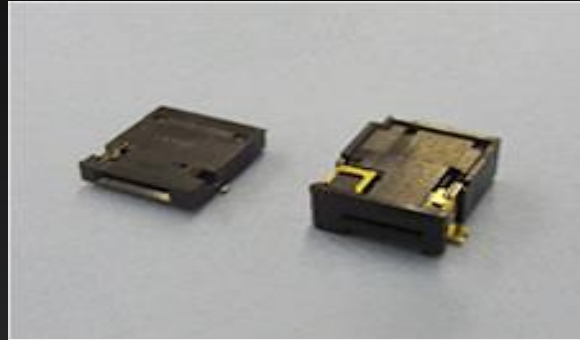

Connectors for medical use



Stylus Pen

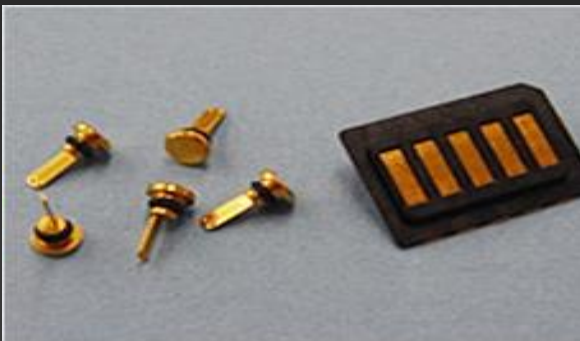

Terminal for charging



Plug Cable Assy



Battery Charging Cradles

# Applications

- Smartphones
- Wearables
- PCs & Laptops
- Audio players
- Medical devices
- e-Readers
- GPS Units
- Power packs/chargers
- Home electronic devices
- Automotive infotainment
- Digital cameras/camcorders etc.

## Connector



## Jack/ Plug



## Antenna



## Battery stand



# Water/ Dust proof Connector & Jack series

---

IPX7 · IP5X **Patented**

## Completed Water & Dust proof

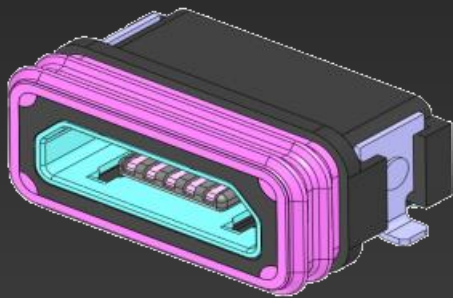

USB Connectors

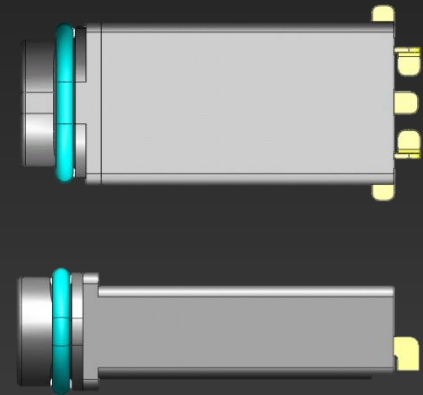
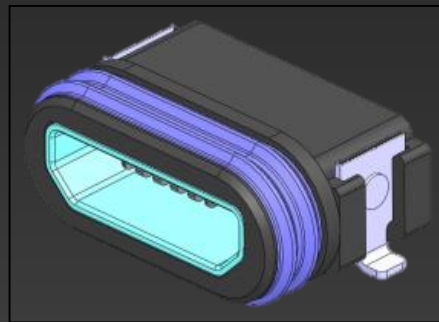

HP Jack

# Multi-pole Jack & Plug (5 to 6-pole) series

- Compatible with standard 3 to 4-pole plugs
- 4 pole + 1 and/or 2 pole = Provide function's expandability to devices

Patented

<5-pole set>

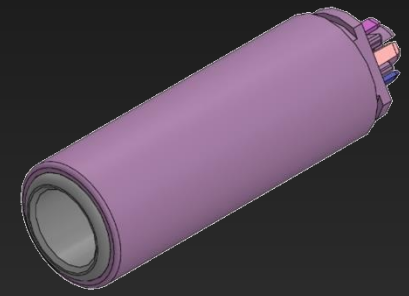
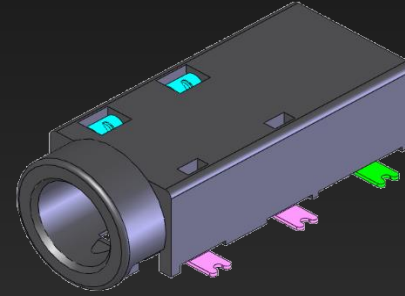
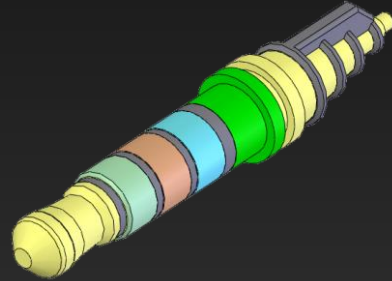

<6-pole set>

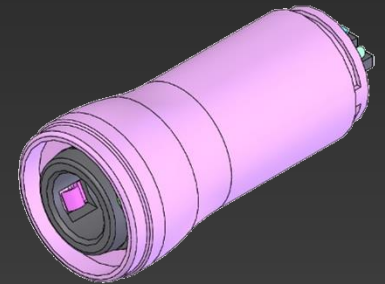
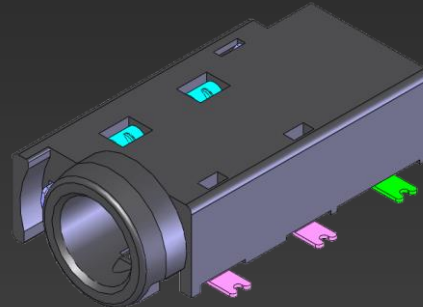
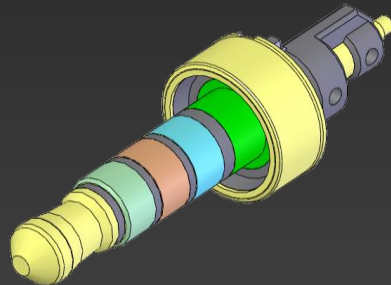

# Extensible Antenna

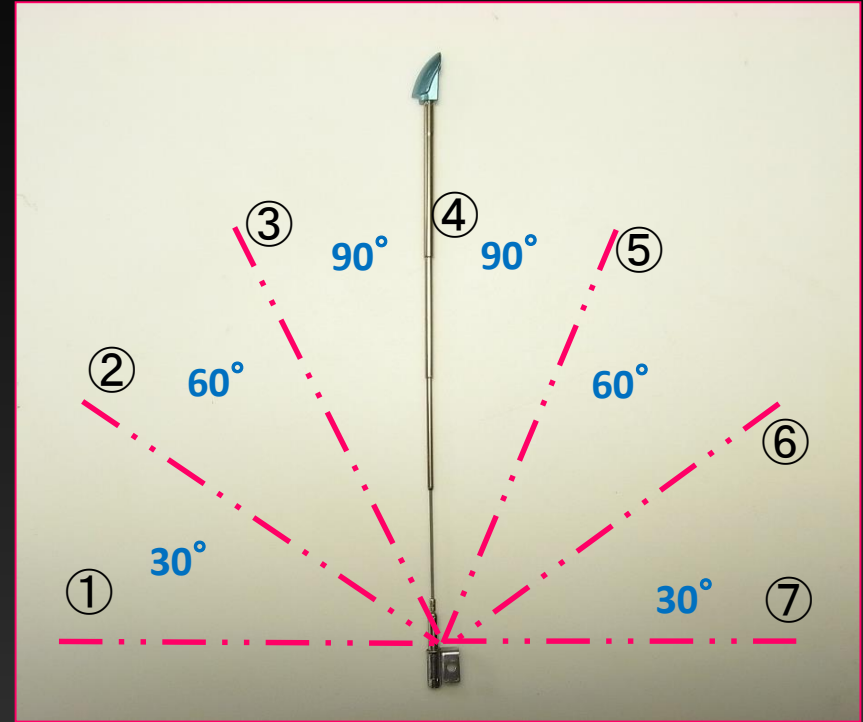
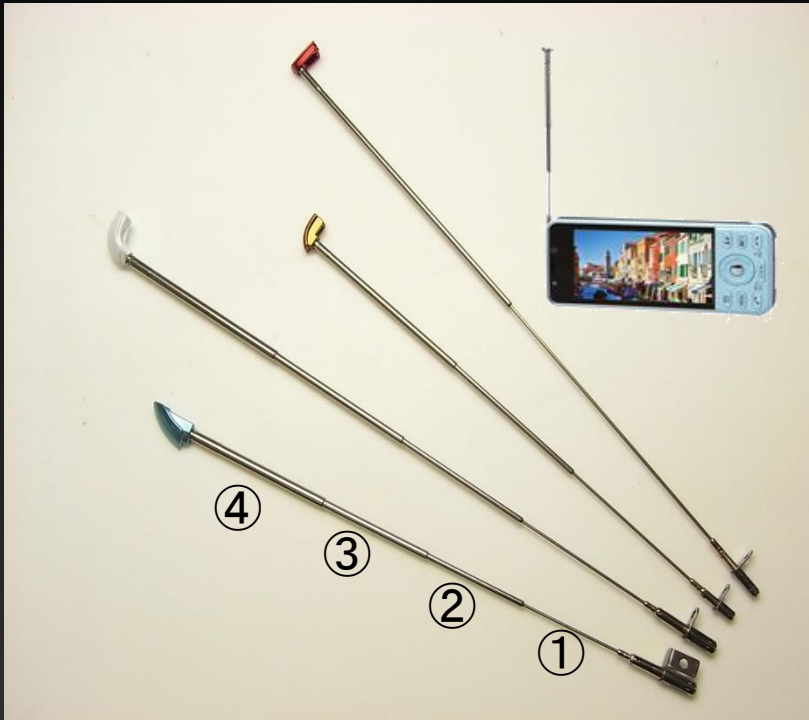

- Up to 4 stages extensibility
- Up to 7 stages flexion with click feeling is available
- Electrical Length range is 120mm~150mm

# Charging Terminals

---



## < Machining Method >

- Cutting, header processing, and combined processing
- Insert molding with pressed parts

## < Metal Plating >

- Gold, Rhodium, and Palladium plating are available

## < Set Supply >

- With spring loaded connector is available

# Cable Assembly

---



## < Manufacturing Service >

- With  $\Phi 3.5$  &  $\Phi 2.5$  plugs & jacks
- With USB connectors & plugs
- Soldering and cutting termination



## < Cable Type >

- EX widely customizes any types of cable even shielded cable



# Custom Products

---

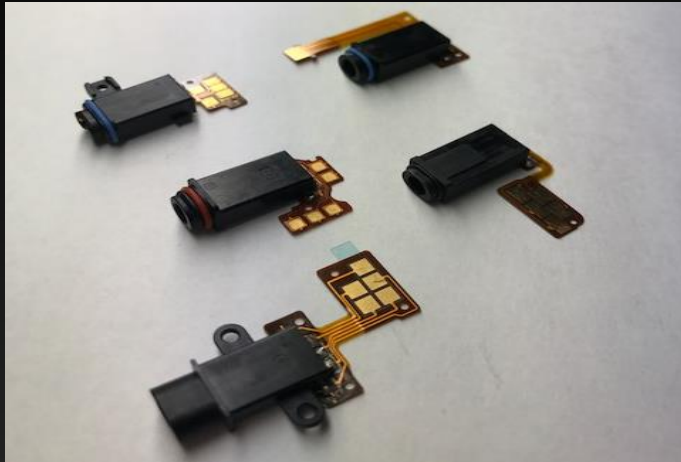

## <With Flexible printed circuits>

- **Mounting service is available**
- **Custom FPC is available**
- **Water-proof performance after mounting is guaranteed**



## <Other Products>

- **Battery charging stands and any optional products as your needs**

# JIG / Production Tooling

---

Any type of JIG/Production Device is available, based on your needs



*Swaging JIG*



*Conduction  
Check Device*



*Insertion JIG*